

**CENTRO CG2C "Curved"**  
1800mm

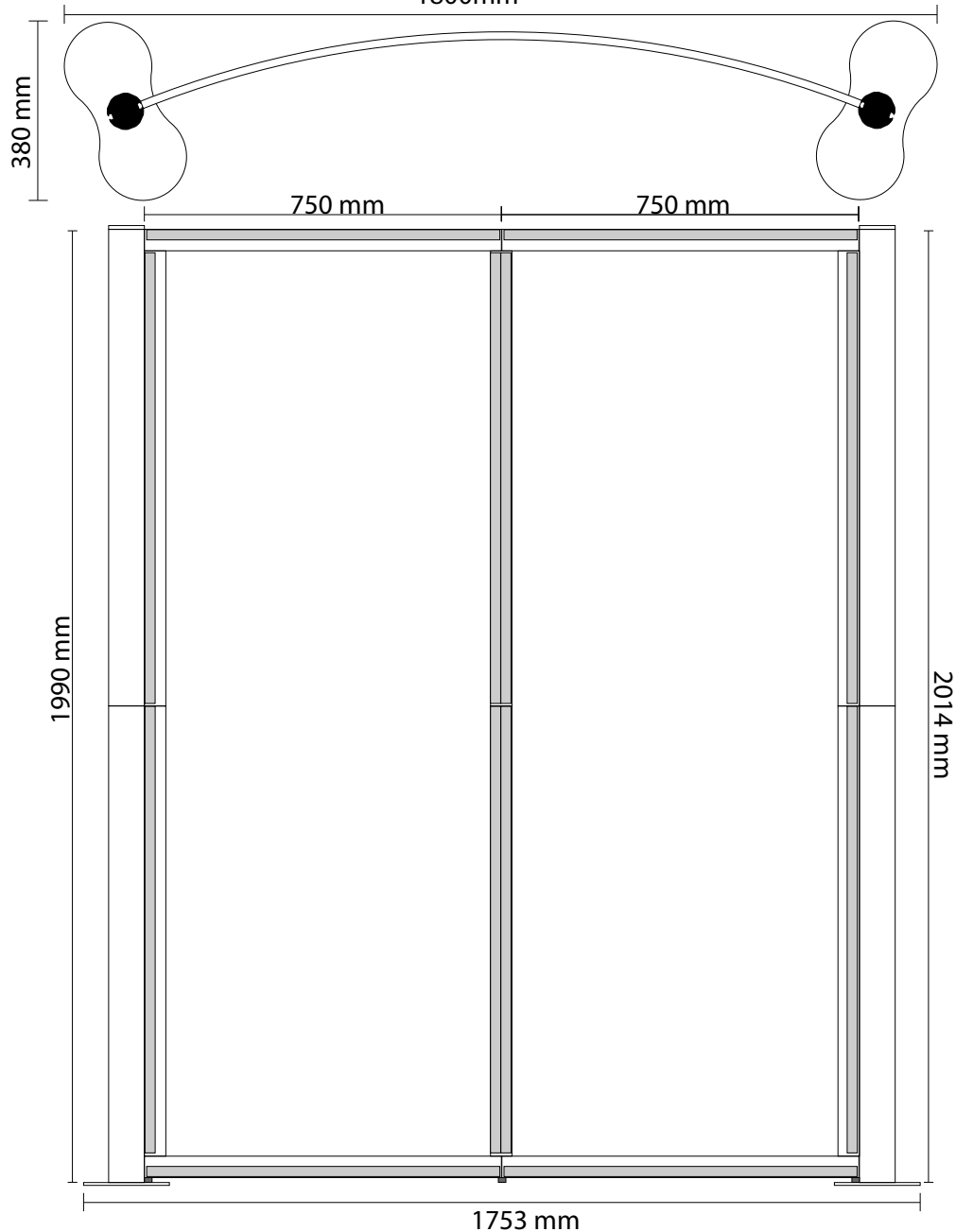

**CENTRO CG2C "Curved"**  
750mm x 2

Base Plate

2

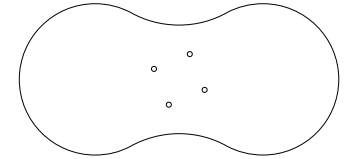

Screws for Base Plate

8



8-way Post

2

Neon Acrylic Cap with 2 Screws

2

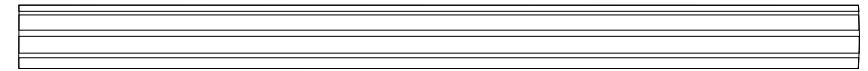

Horizontal Curved Profile  
(750 mm)

4



Vertical Straight Profile-Single steel tape(950 mm)

4

Vertical Straight Profile-Double steel tape(950 mm)

2

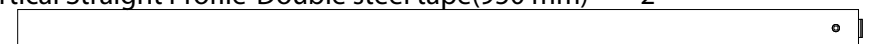

Expanding Clamp with screw

10



Connector Bar with screws

8



Connector Bar (with 3 holes for upside)

1

Connector Bar with adjustable floor screw

1

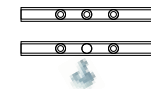

Adjustable feet screw &  
connector bar

2

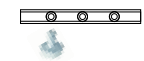

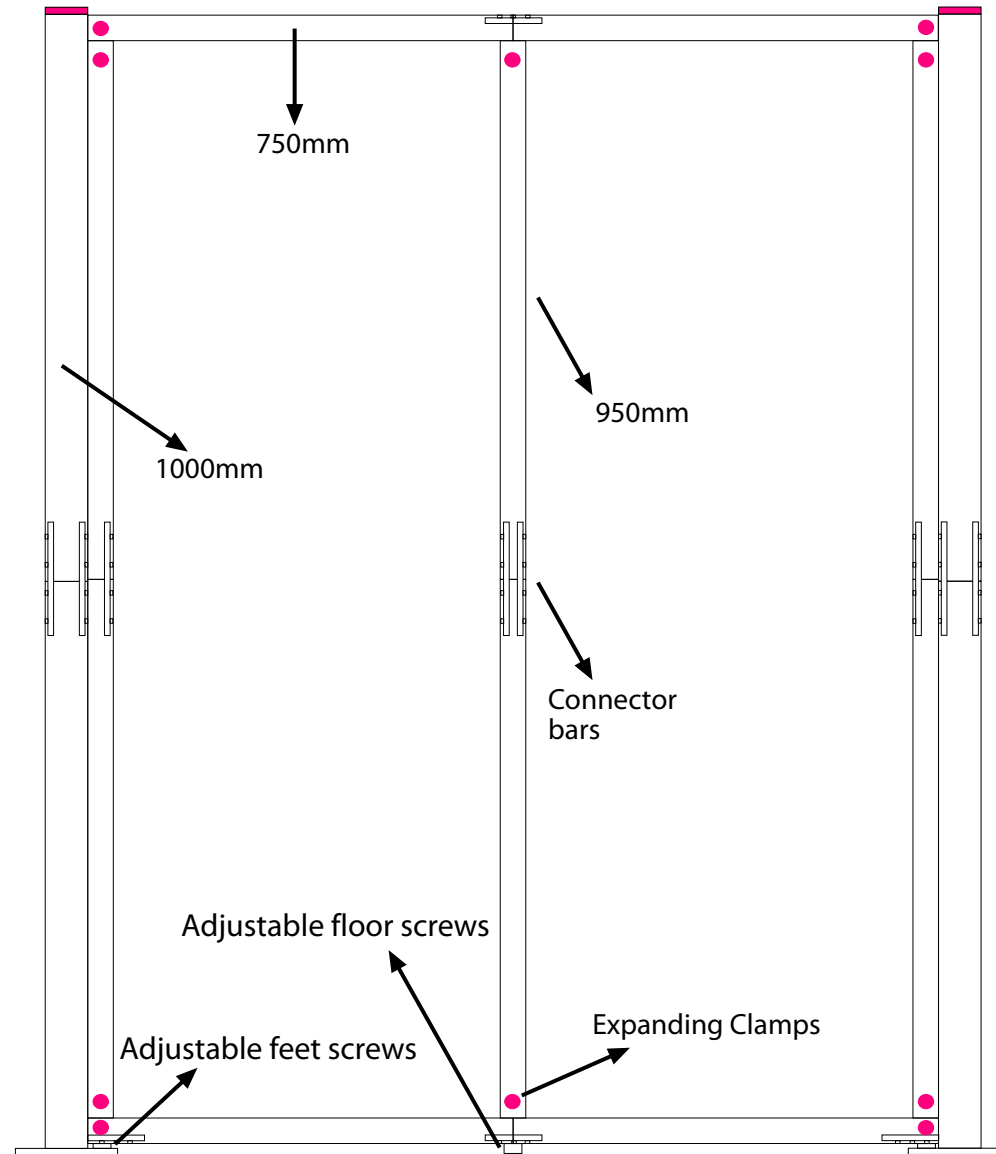

# CENTRO CG2C Assembly Instructions

“Curved”

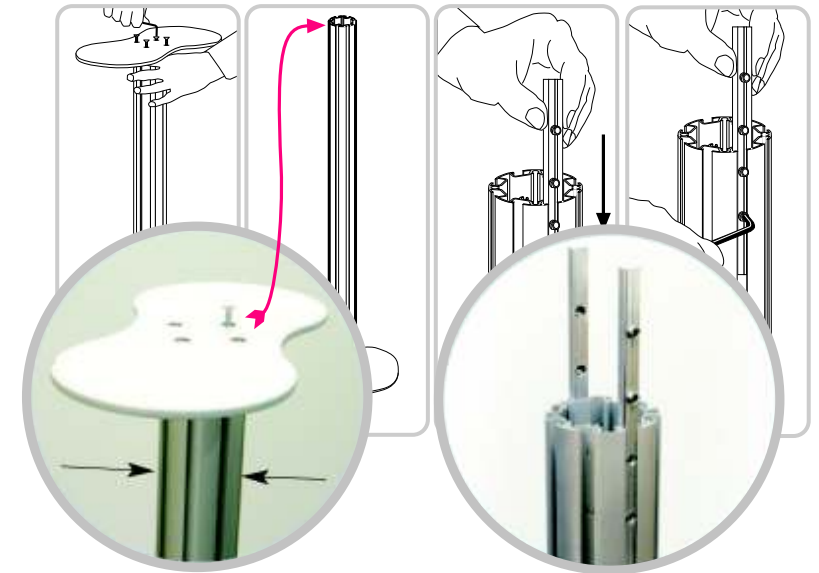
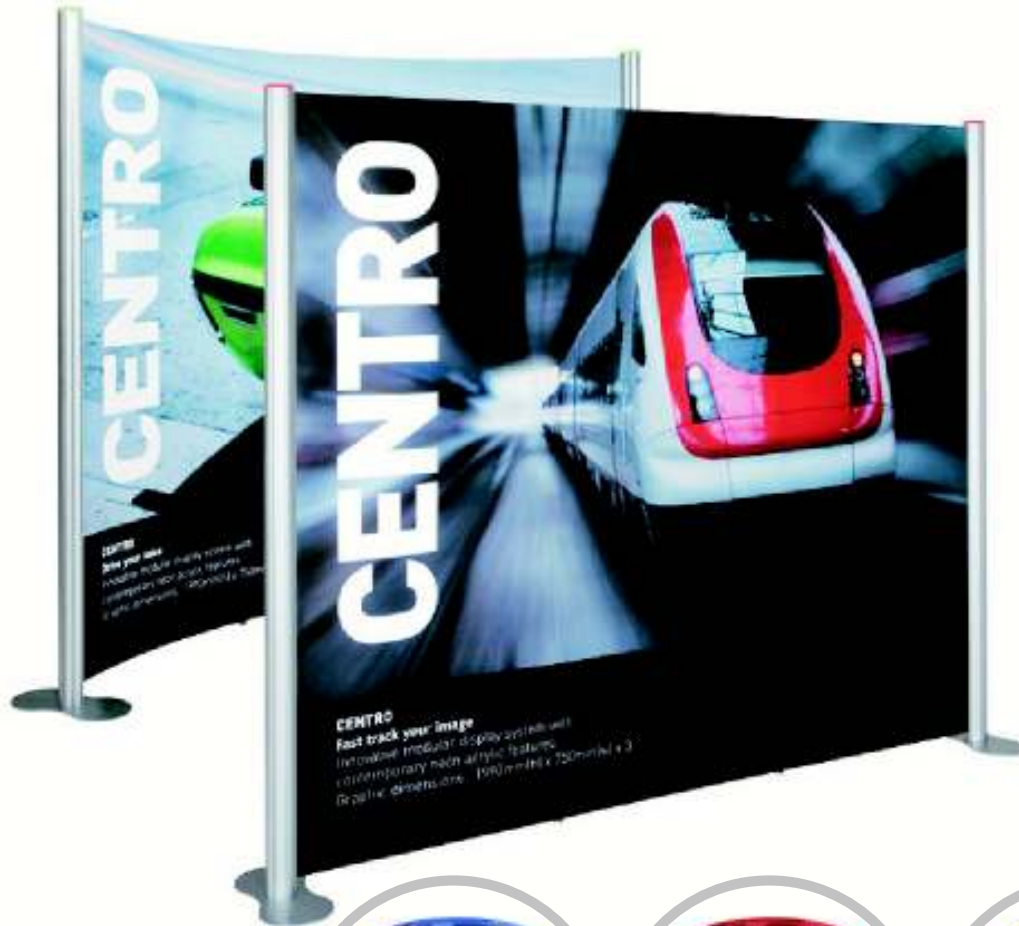

Attach base plate to lower column. Grooves containing connector bars should be at 90° to base plate

Stand base on the ground. Loosen and slide connector bars half way out of groove and retighten.

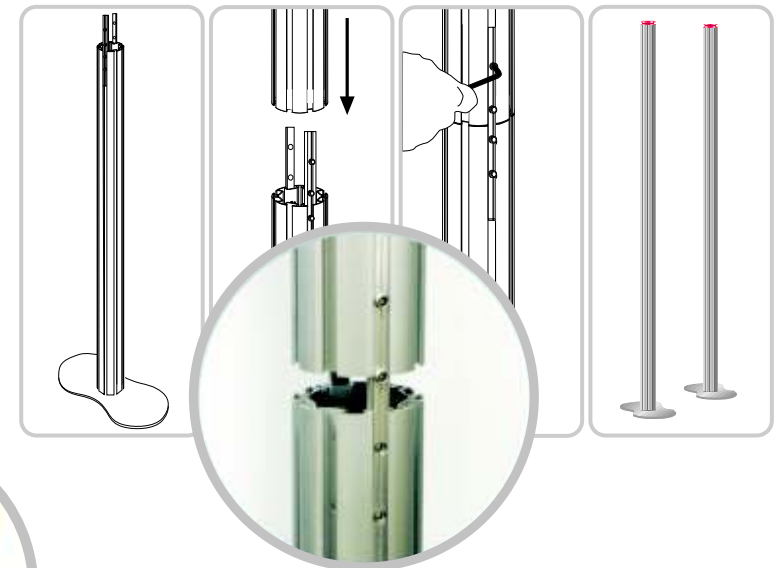

Join posts and tighten the grub screws to make assembly secure. Repeat for other base post.

The adjustable feet should be screwed into the horizontal 750 mm rails used up on the base plates of the system. Note position of tape.

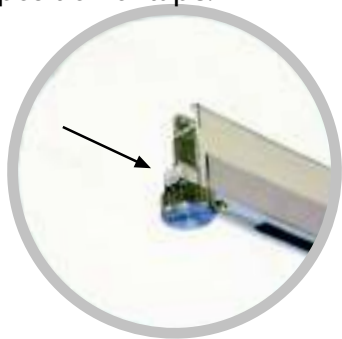

The side and middle\* straight vertical 950 mm graphic rails should now be assembled. Note position of tape strips.

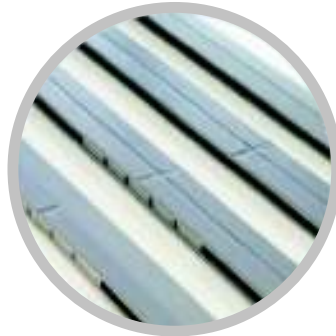

The adjustable floor screw should be screwed into the horizontal 750 mm rails used at the bottom of the system. Note position of graphic fitting strip.

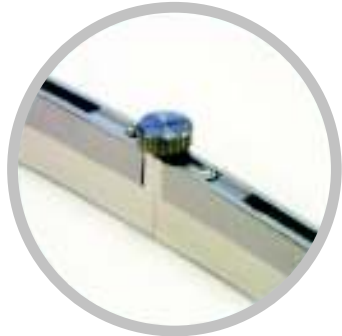

Connect the bottom horizontal rail to the two posts and tighten grub screws as before. Leave top rail until all verticals are in place. They will balance.



Connect side vertical rails to the bottom horizontal rail. The side vertical rails have one run of tape on them. Tape should be nearest the post when viewed from the front. Connect middle rail(s)\* to the bottom rail and tighten grub screws. The middle rails have double graphic fitting strips on them. They will balance. Slot top horizontal rail onto all vertical rails and tighten grub screws.

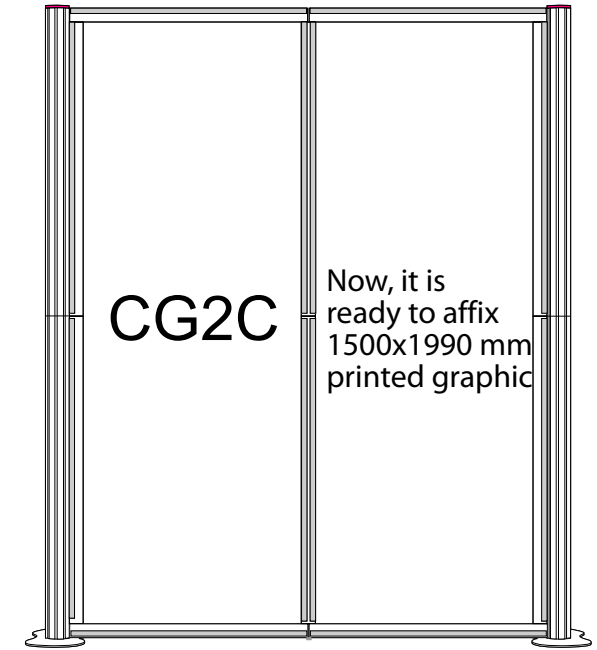

Affix graphics to the tape starting from the top and side, working across the completed system.



## Graphic specifications & Accessories

### Graphic Specification :

1990 mm(high)x750 mm (wide)  
(2 panels)

Net weight. 16.7 kg.

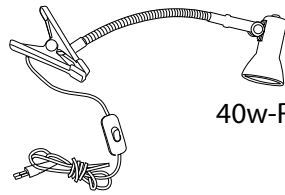

40w-R 50 spotlight



Silver colored steel or  
neon acrylic  
brochure holder (A4)

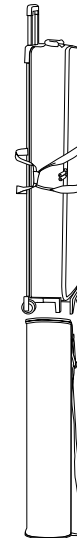

Trolley bag

Graphic carry bag

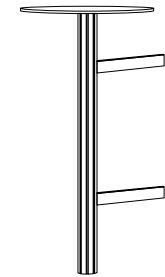

Podium kit

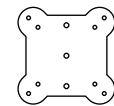

LCD Bracket